



MAX4117 Evaluation Kit

General Description

The MAX4117 evaluation kit (EV kit) simplifies evaluation of the MAX4117 dual, high-speed, current-mode feedback amplifiers. The EV kit circuit demonstrates the MAX4117 in the noninverting configuration set to a gain of 2V/V. RF-style connectors (SMA) and 50Ω terminating resistors are included.

The EV kit comes with the MAX4117 installed. To evaluate the MAX4118, simply order a free sample (MAX4118ESA), replace the MAX4117 with the MAX4118 on the EV board, and change the gain-setting resistors for the desired gain. The minimum closed-loop gain for the MAX4118 is 8V/V.

Component List

DESIGNATION	QTY	DESCRIPTION
C1, C2	2	0.1μF, 10% ceramic capacitors Vitramon VJ1206Y104KXX
C3, C4	2	10μF, 10V, 20% tantalum capacitors AVX TAJB106M010 Sprague 293D106X0010B
INA, INB, OUTA, OUTB	4	SMA connectors
R1, R2, R3, R4	4	49.9Ω, 1% resistors
RFA, RFB, RGA, RGB	4	499Ω, 1% resistors
U1	1	MAX4117ESA
None	1	MAX4117 EV kit PC board
None	1	MAX4112/MAX4113/MAX4117/ MAX4118 data sheet

Component Suppliers

SUPPLIER	PHONE	FAX
AVX	(803) 946-0690	(803) 626-3123
Sprague	(603) 224-1961	(603) 224-1430
Vishay/Vitramon	(203) 268-6261	(203) 452-5670

Features

- ◆ **Optimized for Less than -70dB Crosstalk at 10MHz**
- ◆ **Adjustable Gain**
- ◆ **Fully Assembled and Tested**

Ordering Information

PART	TEMP. RANGE	BOARD TYPE
MAX4117EVKIT	+25°C	Surface Mount

Note: To evaluate the MAX4118, request a MAX4118ESA sample.

Quick Start

The MAX4117 EV kit is fully assembled and tested. Follow these steps to verify board operation. **Do not turn on the power supply until all connections are completed.**

- 1) Connect the +5V supply to the VCC pad and the -5V supply to the VEE pad. Connect the power-supply ground to the GND pad.
- 2) Apply a signal of ±1.55V max to either input marked INA or INB.
- 3) Connect the appropriate output (OUTA or OUTB) for the input selected in step 2, to an oscilloscope through a terminated 50Ω cable.
- 4) Verify the output signal on the oscilloscope.

Evaluates: MAX4117/MAX4118

MAX4117 Evaluation Kit

Detailed Description

Voltage-Gain Adjustment

The MAX4117's gain can be adjusted with minor modifications to the evaluation board:

- 1) Select feedback (R_F) and gain-set (R_G) resistors from Table 1 for the desired gain.
- 2) Install R_F and R_G .

Table 1. Gain-Set Resistors

GAIN	$R_F(\Omega)$	$R_G(\Omega)$	SMALL-SIGNAL BANDWIDTH (MHz)	DEVICE
2	499	499	330	MAX4117
10	499	56	160	MAX4118
26	499	20	75	MAX4118

Layout Considerations

The MAX4117 EV kit layout has been optimized to minimize crosstalk of high-speed signals. Careful attention has been given to grounding, power-supply bypassing, and signal-path layout. Small surface-mount, ceramic bypass capacitors (C_1 , C_2) are placed as close to the MAX4117 supply pins as possible. To reduce crosstalk, the feedback resistors are kept apart. The ground plane has been removed under and adjacent to the MAX4117 to reduce stray capacitance.

Use the alternative layouts shown in Figures 5, 6, and 7 to achieve up to 500MHz bandwidth. This layout provides higher bandwidth at the expense of crosstalk. The removal of ground plane around the input SMA connectors reduces distortion. Refer to the *Layout and Power-Supply Bypassing* section of the MAX4117 data sheet for further details.

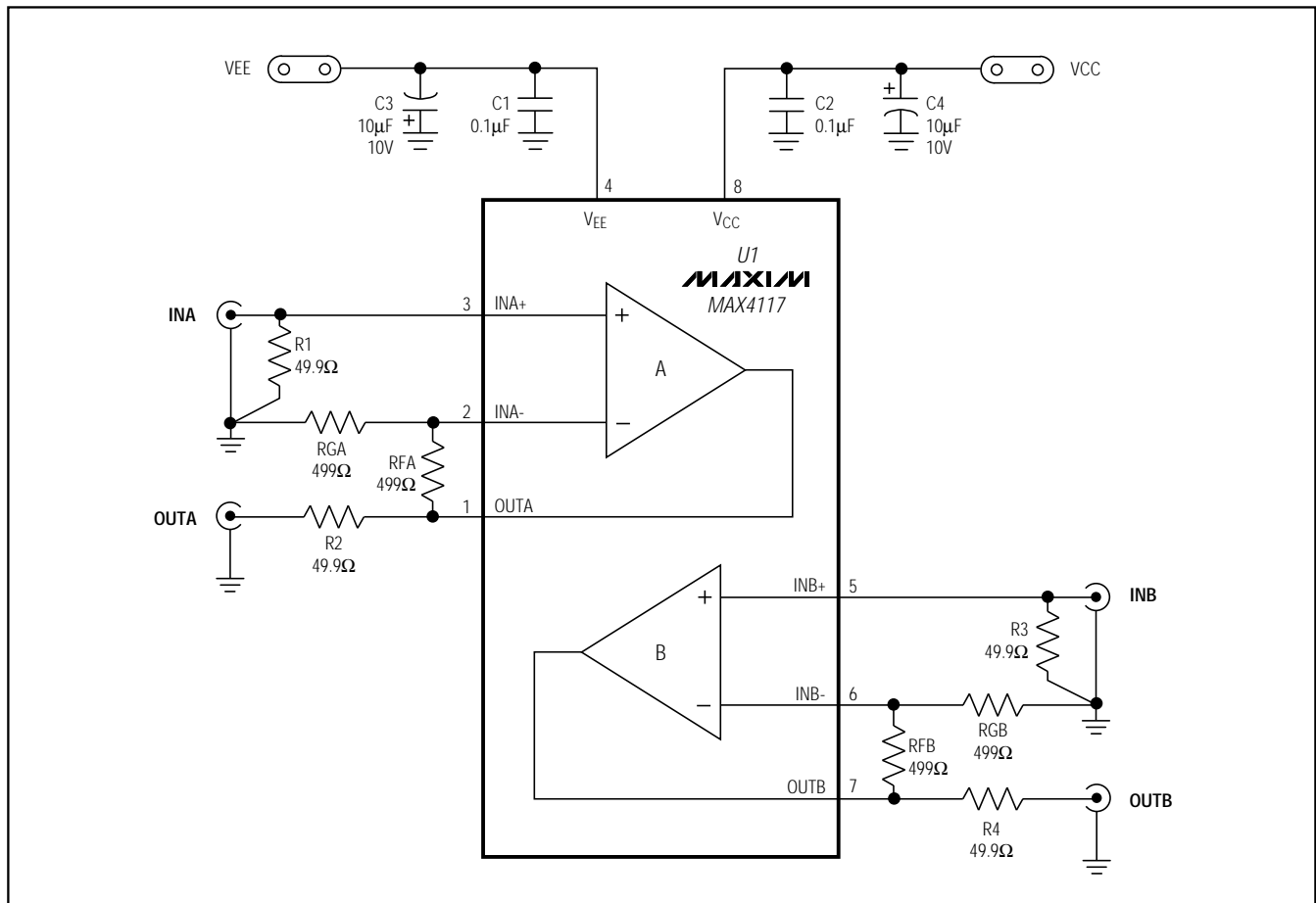

Figure 1. MAX4117 EV Kit Schematic

MAX4117 Evaluation Kit

Evaluates: MAX4117/MAX4118

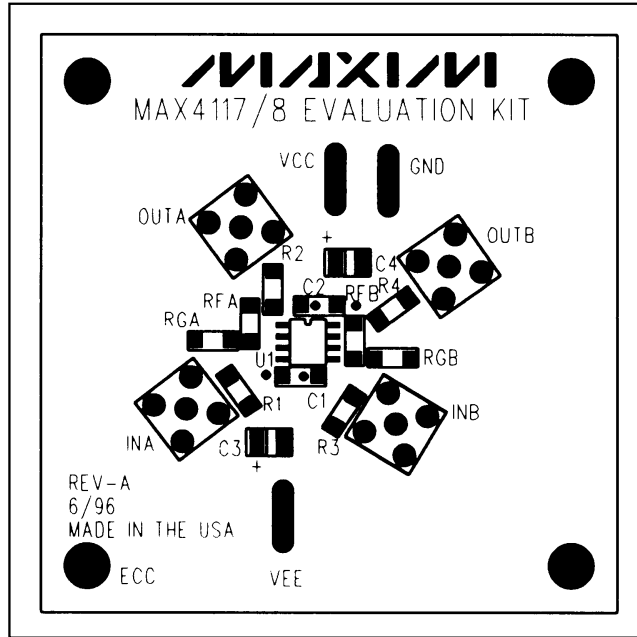

Figure 2. MAX4117 EV Kit Component Placement Guide—Component Side

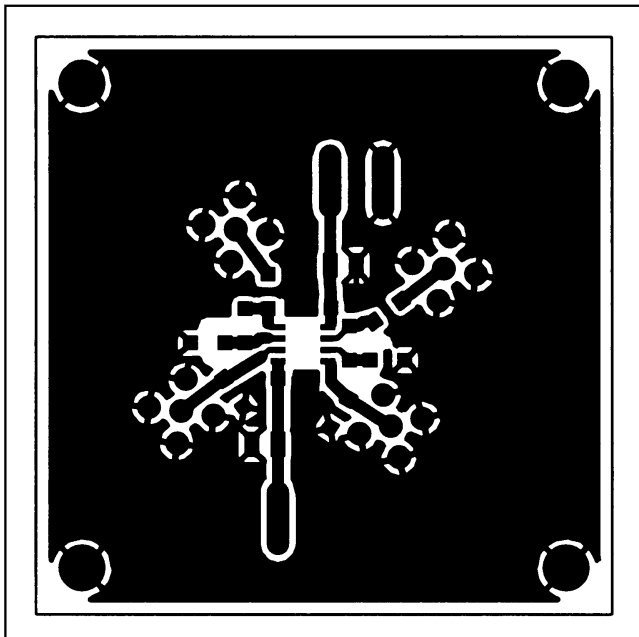

Figure 3. MAX4117 EV Kit PC Board Layout—Component Side

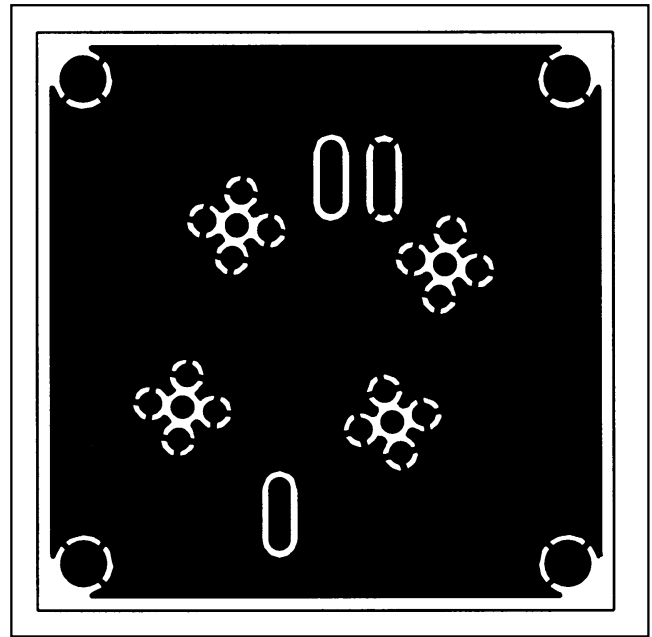

Figure 4. MAX4117 EV Kit PC Board Layout—Solder Side

MAX4117 Evaluation Kit

Evaluates: MAX4117/MAX4118

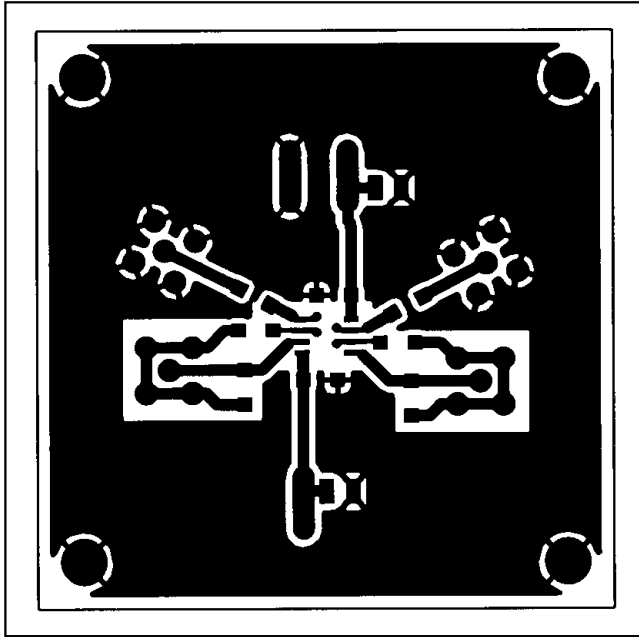

Figure 5. PC Board Layout—Component Side

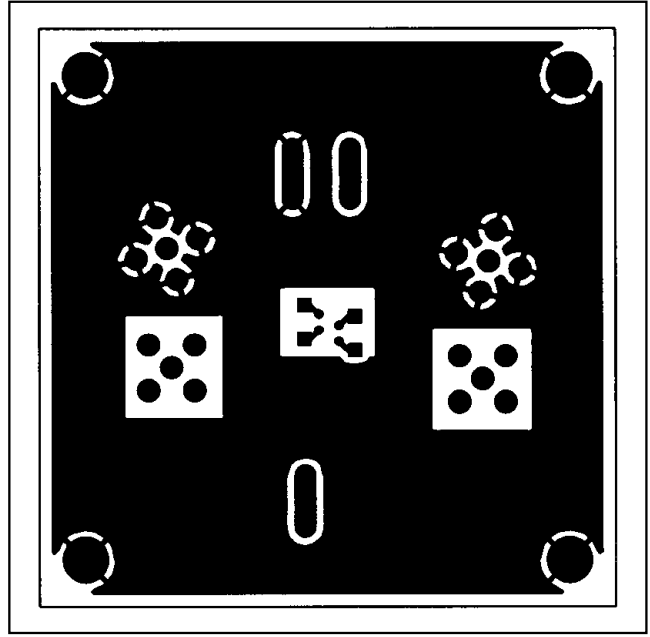

Figure 6. PC Board Layout—Solder Side

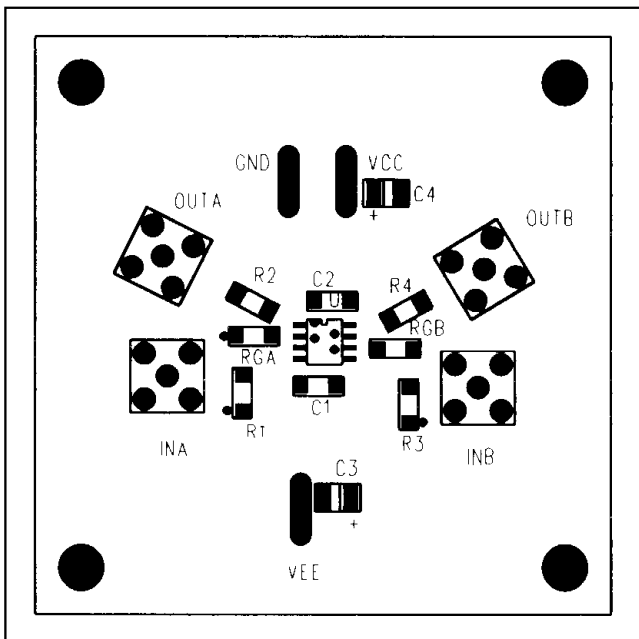

Figure 7. Component Placement Guide—Component Side

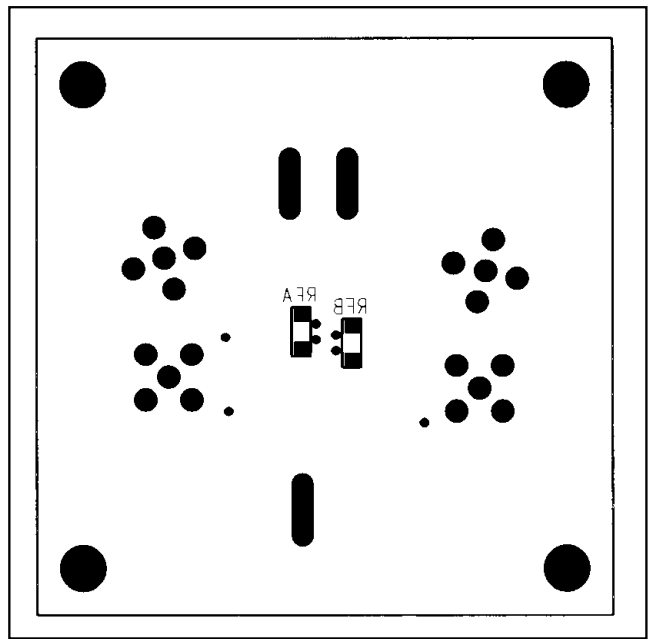

Figure 8. Component Placement Guide—Solder Side

Maxim cannot assume responsibility for use of any circuitry other than circuitry entirely embodied in a Maxim product. No circuit patent licenses are implied. Maxim reserves the right to change the circuitry and specifications without notice at any time.

4 _____ Maxim Integrated Products, 120 San Gabriel Drive, Sunnyvale, CA 94086 (408) 737-7600